

REV.	NOTES	DATE
B	尺寸49.40變更爲49.60±0.10，尺寸50.00變更爲50.20 <sup>±0.00</sup> ，短腳處變更爲圓弧，增加視圖C	2005/11/18
C	修改尺寸:50.20 <sup>±0.00</sup> →47.1	2005/12/21
D	修改尺寸公差	2006/09/13
E	增加尺寸:5.05±0.15,1.94	2006/11/13
F	增加端子阻抗	2006/12/09
G	增加重點尺寸標示	2007/02/02

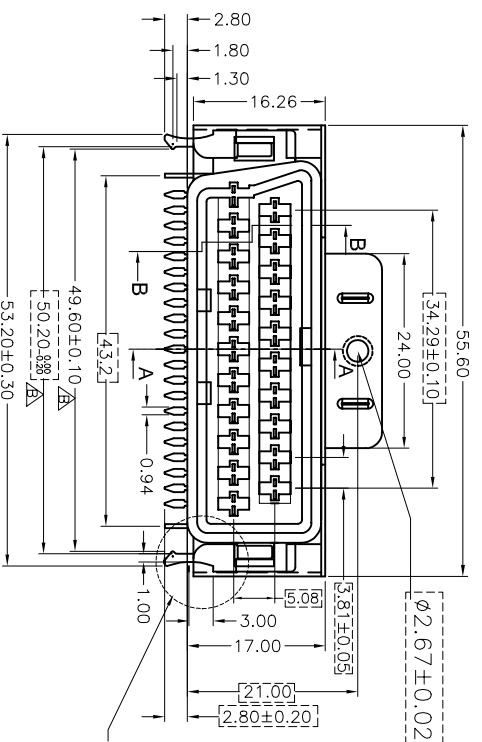

修改處

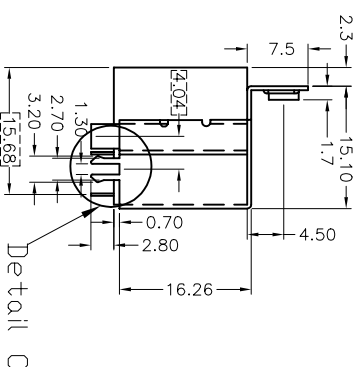

Detail C

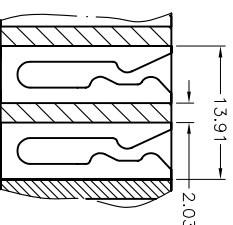

SEC A-A

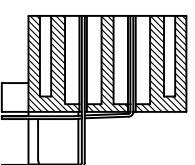

SEC B-B

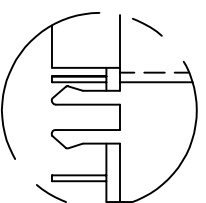
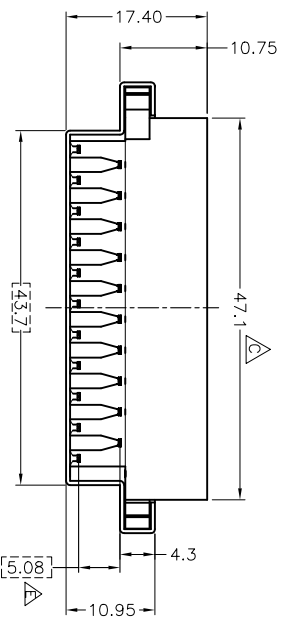

Detail "C" S: 2/1

- NOTES:
- MATERIALS
    - Insulator: PBT
    - Contact: Brass 0.3T
    - Material sheel: SPCC 0.5T
    - Contact plating: TIN plated
  - SPECIFICATIONS
    - Current Rating: 3Amp
    - Contact Resistance: 25m Ohms Max
    - Dielectric Strength: 1000V AC for one minute
    - Insulator Resistance: 1000M Ohms Min.(at 500V DC)
    - Operation Temperature: -55°C to +105°C

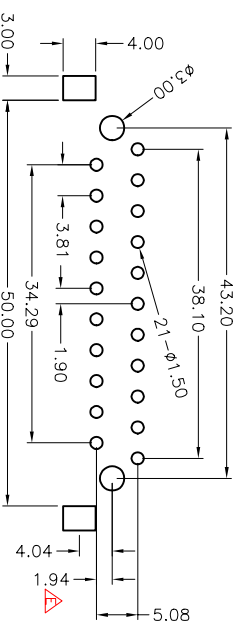

DIMENSIONS TOLERANCE

METRIC

- .0 = ±.25
- .00 = ±.15
- .000 = ±.05
- RADIUS ±0.25
- HOLE ±0.13
- ANG. = ± 1°



備注:

增加重點尺寸標示: [XX]

單位 (UNITS)	mm	圖名 (NAME)
數量 (QTY)	N/A	90度母座有柱有孔,黑無毒PBT短腳 無毒
材料 (M'T'L)	SEE NOTE	料號 (PART NUMBER)
處理 (FINISH)	SEE NOTE	圖號 (DRAW NUMBER)
繪圖 (DRAW)		圖檔 (FILE NAME .DWG)
設計 (DE'N)		比例 (SCALE)
審核 (CH'K)		圖紙 (SHEET)
核准 (APP' D)		頁次 (SHEET)
		版本 (REV.)

A 1 2 3 4 5 6 7 8 9 10 11 12 13 14