

RoHS Compliance

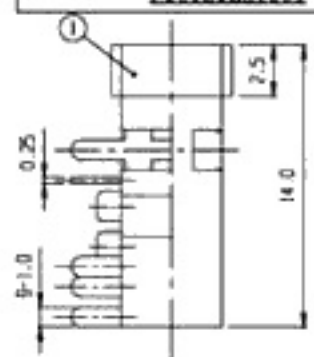
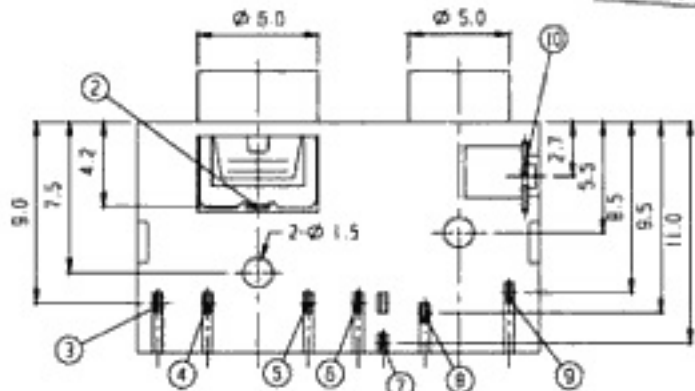
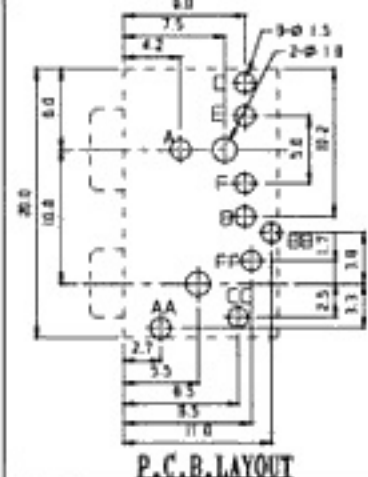

ST-3525-14

ST-3525-13

ST-3525-12

ST-3525-11

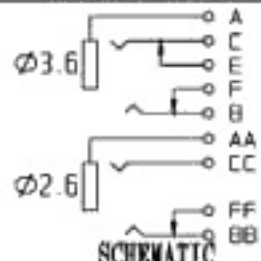
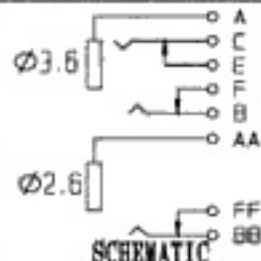
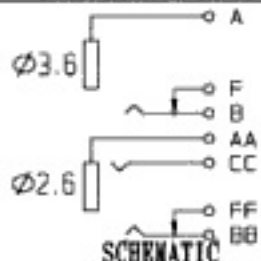
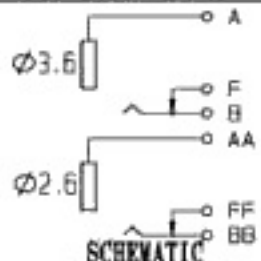

9	SPRING PLATE	S U S	1	Ag PLATED
7	SPRING PLATE	S U S	1	Ag PLATED
5	TERMINAL	BRASS	1	Ag PLATED
3	SPRING PLATE	S U S	1	Ag PLATED
1	FRAME	NYLON 43	1	
NO.	PART	MATERIAL	QTY	REMARKS

10	SPRING PLATE	P B S	1	Ag PLATED
8	TERMINAL	BRASS	1	Ag PLATED
6	SPRING PLATE	S U S	1	Ag PLATED
4	TERMINAL	BRASS	1	Ag PLATED
2	SPRING PLATE	P B S	1	Ag PLATED
NO.	PART	MATERIAL	QTY	REMARKS

ISSUED

SPECIFICATION

TITLE: 3.5mm/2.5mm STERED JACK



RATING: DC 30V 0.3A  
 CONTACT RESISTANCE: 50mΩ max.  
 INSULATION RESISTANCE: 100MΩ AT 500V DC  
 WITHSTAND VOLTAGE: AC 250V for 1 minute  
 OPERATION FORCE: REFER ATTACH SPECIFICATION  
 SWITCHING LIFE: 5k cycles min.

MODEL NO: ST-3525-11

TOLERANCE	UNIT: MM	DWN.	<i>hoo</i>
UP TO 1.0: ±0.1	SCALE: 3:1	CHK'D.	<i>mm</i>
1.0 TO 10.0: ±0.2	VERSION: 02	APPD.	<i>[Signature]</i>
OVER 10.0: ±0.3	DRWG NO:		